



Proportional directional valve based automatic steering system for tractors^{*}

Jin-yi LIU, Jing-quan TAN, En-rong MAO, Zheng-he SONG, Zhong-xiang ZHU^{†‡}

(Beijing Key Laboratory of Optimized Design for Modern Agricultural Equipment, China Agricultural University, Beijing 100083, China)

[†]E-mail: zhuzhonxiang@cau.edu.cn

Received May 30, 2015; Revision accepted Sept. 8, 2015; Crosschecked Apr. 13, 2016

Abstract: Most automatic steering systems for large tractors are designed with hydraulic systems that run on either constant flow or constant pressure. Such designs are limited in adaptability and applicability. Moreover, their control valves can unload in the neutral position and eventually lead to serious hydraulic leakage over long operation periods. In response to the problems noted above, a multifunctional automatic hydraulic steering circuit is presented. The system design is composed of a 5-way-3-position proportional directional valve, two pilot-controlled check valves, a pressure-compensated directional valve, a pressure-compensated flow regulator valve, a load shuttle valve, and a check valve, among other components. It is adaptable to most open-center systems with constant flow supply and closed-center systems with load feedback. The design maintains the lowest pressure under load feedback and stays at the neutral position during unloading, thus meeting the requirements for steering. The steering controller is based on proportional-integral-derivative (PID) running on a 51-microcontroller-unit master control chip. An experimental platform is developed to establish the basic characteristics of the system subject to stepwise inputs and sinusoidal tracking. Test results show that the system design demonstrates excellent control accuracy, fast response, and negligible leak during long operation periods.

Key words: Automatic steering system, Hydraulic circuit, Proportional directional valve, Proportional-integral-derivative (PID) control

<http://dx.doi.org/10.1631/FITEE.1500172>

CLC number: TP273; TH137.52

1 Introduction

With the development of automation, the progress of research on automatic guidance technologies has become increasingly better, so that automatic steering technologies can be constantly updated. As a key technology in farming equipment navigation (Reid *et al.*, 2000; García-Pérez *et al.*, 2008), the control accuracy of an automatic steering system determines the control accuracy of the automatic navigation system. Automatic steering control is of great significance for realizing intensive agricultural

production. A qualified automatic steering system requires high control accuracy, good reliability, and fast response (Dong *et al.*, 2002; Chen *et al.*, 2006; Zhu *et al.*, 2007). To achieve these, many methods have been proposed. Zhang *et al.* (2000) and Qiu *et al.* (2001) designed an electrohydraulic (E/H) steering control system for agricultural vehicles and developed a fuzzy steering controller with this E/H steering control system. Inoue *et al.* (2004) developed an E/H servo automatic steering control system for applications in an autonomous semi-crawler tractor. He *et al.* (2007) conducted research on a TD654L tractor (Tianjin Tractor Manufacturing Corporation Ltd., China) mounted with a proportional directional valve and tested the automatic system by following the guidance signal. Luo *et al.* (2009) designed a hydraulic steering system with electric

[‡] Corresponding author

^{*} Project supported by the Synergistic Innovation Center of Modern Agricultural Equipment and Technology, China (No. NZXT01201401)

ORCID: Jin-yi LIU, <http://orcid.org/0000-0001-7375-9614>

© Zhejiang University and Springer-Verlag Berlin Heidelberg 2016

control, which is connected in parallel with the original mechanical steering system. However, the new steering system does not interact with the old steering system. Wu *et al.* (2009) designed an E/H mechanism; i.e., connects in parallel with the original steering system to finish steering automatically.

The traditional automatic hydraulic steering system on farming equipment is usually designed for oil supply systems with either constant current or constant pressure, sometimes even for a designated tractor type, making the system neither adaptable nor promotable. Moreover, most of the common full-hydraulic automatic steering valves lack an unloading circuit in the neutral position. For example, Wu *et al.* (2009) and Shen *et al.* (2014) applied the 4-way-3-position proportional directional valve with the O-typical function (the pressure oil port, oil outlet, and working ports are all closed when the valve spool is in the neutral position), in their hydraulic systems, which will result in high pressure, large energy consumption, temperature rise, and serious leaking problems during long-time operations. In view of the abovementioned problems, here we present a proportional integrated control valve block for different steering hydraulic systems. The block is composed of a 5-way-3-position proportional directional valve, two pilot-controlled check valves, a pressure-compensated directional valve, a pressure-compensated flow regulator valve, a load shuttle valve, and a check valve. This hydraulic circuit is adaptable to navigation systems on self-propelled farming equipment with hydraulic steering of open-center, closed-center, and load-sensing types.

2 System configuration

The automatic steering system depicted in Fig. 1 includes a hydraulic oil source, a 5-way-3-position proportional directional valve and its power

amplifier, a hydraulic steering cylinder, steering trapezium bars, a deflection roller and its angle sensor, an analog-to-digital converter (ADC), a digital-to-analog converter (DAC), and a microcontroller unit (MCU).

3 System hardware

3.1 Development of proportional integrated valve

Most commonly used on large- and medium-sized tractors and harvesters, steering systems with hydraulic steering gears can be classified into three types, namely, open-center system, closed-center system, and load feedback sensing system. Considering the basic characteristics of the hydraulic steering system found in most agricultural equipment and the design principles they follow, a multifunctional automatic hydraulic steering circuit is developed (Fig. 2). This particular circuit, which consists of a 5-way-3-position proportional directional valve (5), two pilot-controlled check valves (6), a pressure-compensated directional valve (3), a differential pressure spillover valve (1), and a load shuttle valve (4), can be used for open-center, closed-center, and load feedback sensing systems.

In the integrated valve block, the proportional directional valve is a hydraulic screw-in 5-way-3-position valve showing the Y-typical function (the pressure oil port is closed, and the oil outlet connects with working ports when the valve spool is in the neutral position) and load feedback sensing ports. The 4-way-3-position proportional valve is integrated with a pressure-sensing shuttle valve, rendering the integral component a smaller loss. The main function of the differential-pressure spillover valve (1) along with the pressure-compensated directional valve is to offer pressure compensation for the inlet of the proportional directional valve. Therefore, the output pressure remains constant, thus making its opening

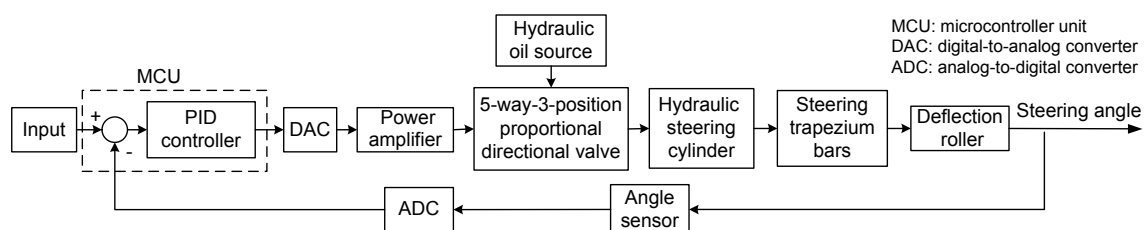

Fig. 1 Diagram of the automatic steering system of a tractor

size, other than the load pressure, be the only determinant of the output flow. The main function of the two pilot-controlled check valves (6) is to interlink the load pressure sensing port with the oil outlet when the proportional directional valve is in the neutral position to make the pressure approximately zero. Additionally, the excellent leakproofness of the valve prevents the negative effect imposed by the automatic steering system when it is not operating.

When the integrated valve block is used in an open-center system, plugging the pressure port P_1 and the two load pressure feedback ports LS_{in} and LS_{out} will render the pressure-compensated directional valve (3) to be of no avail. Thus, the fluid pressure port P_2 , outlet T , and cylinder ports A and B are connected in parallel through a 3-way pipe and the circuit of the hydraulic steering gear. Now, a portion of the fluid from P_2 will flow into the steering hydraulic cylinder through the proportional directional valve, and the remainder will flow into the oil tank through the differential-pressure spillover valve. The control passages on the two sides of the differential-pressure spillover valve core (1) are connected respectively to the entrance and exit of the proportional directional valve (5), so that any change

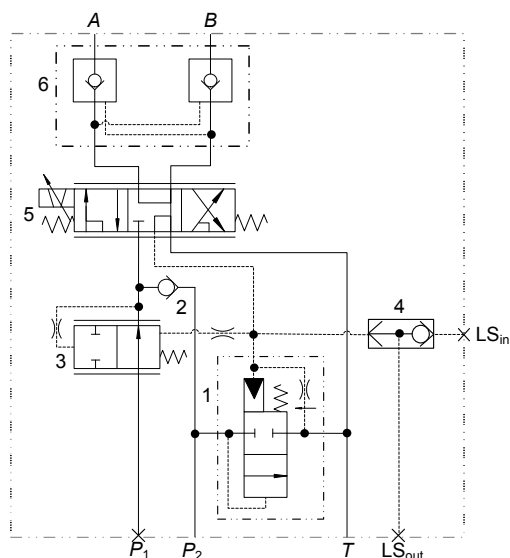

Fig. 2 Diagram of the multifunctional automatic hydraulic steering circuit

P_1 and P_2 : pressure oil ports; T : oil outlet; A and B : steering hydraulic cylinder interfaces; LS_{in} and LS_{out} : load pressure feedback ports; 1: differential-pressure spillover valve; 2: check valve; 3: pressure-compensated directional valve; 4: spillover throttle valve; 5: proportional directional valve; 6: two pilot-controlled check valves

in the opening size of valve (1) may offer (parallel) pressure compensation as the load pressure changes. Therefore, the pressure difference between the inlet and outlet remains constant, and the flow is sensitive only to the valve's opening size (i.e., input current) but not to the load pressure. When valve (5) is in the neutral position (where input current is zero), the check valve (6) locks the steering hydraulic cylinder. The pressure of valve (5) is close to zero when the load feedback sensing passage is connected to the fluid outlet. At this juncture, valve (1) begins to overflow at a very low pressure (because the preload of its spring is small), and the system is in the unloading state.

When the integrated valve block is used in a closed-center system, pressure port P_2 and load pressure feedback ports LS_{in} and LS_{out} are plugged. The pressure port P_1 , outlet T , and cylinder ports A and B are connected in parallel through the 3-way pipe and the circuit of the hydraulic steering gear. Generally, the charging pump of a closed-center system is a constant-pressure variable pump, and fluid from P_1 is fed into the hydraulic cylinder through the throttles of valves (3) and (5). Meanwhile, the check valve (2) is closed, so the differential-pressure spillover valve does not function, as there is no fluid flowing through it. The control passages on the two sides of the core of the pressure-compensated directional valve (3) are connected respectively to the entrance and exit of the proportional directional valve (5), so a change in the opening size of the valve (3) offers the (series) pressure compensation as the load pressure changes. Therefore, the pressure difference between the inlet and outlet of the valve (5) remains constant, and the flow is subject only to the valve's opening size (i.e., input current) but not to the load pressure.

When the integrated valve block is used in a load feedback sensing system, the pressure port P_2 is plugged. The pressure port P_1 , outlet T , and cylinder ports A and B are connected in parallel through the 3-way pipe and the circuit of the hydraulic steering gear, and then the load pressure feedback port LS_{in} is linked to the load feedback sensing port of the hydraulic steering gear and LS_{out} to the same port on the stable-flow compensation valve. Afterward, fluid from P_1 is fed into the hydraulic cylinder via the throttles of the valves (3) and (5). Meanwhile, the

check valve (2) is closed, so the differential-pressure spillover valve will not function, as there is no fluid flowing through it. The control passages on the two sides of the core of the pressure-compensated directional valve (3) are respectively connected to the entrance and exit of the proportional directional valve (5), so that a change in the opening size of the valve (3) may offer the (series) pressure compensation as the load pressure changes. Therefore, the pressure difference between the inlet and outlet of the valve (5) remains constant, and the flow is subject only to the valve's opening size (i.e., input current) but not to the load pressure. When the valve (5) is in the neutral position (where the input flow is zero), the check valve (6) locks the steering hydraulic cylinder. The pressure of the valve (5) is close to zero, as the load feedback sensing passage is connected to the oil outlet. At this moment, the load pressure feedback ports LS_{in} and LS_{out} are connected by the spillover throttle valve (4), and the steering function is achieved by the hydraulic steering gear.

3.2 Controller design

As for the hardware structure (Fig. 3), the controller consists of the main control chip, the analog-to-digital (AD) module, the digital-to-analog (DA) module, the RS-485 bus, etc. The main control chip of the MCU is STC90C516RD (STC MCU Ltd., China), which has strong anti-interference ability, low power consumption, high processing speed, and a wide range of adaptability. The software is coded with C language in the Keil C51 development environment. Therefore, its instruction codes have good compatibility.

3.3 Installation and calibration of the front-wheel angle sensor

The WYH-3 angular displacement sensor (Beijing Torch Sensor Tech. Co., Ltd., China) (Fig. 4) is selected as the front-wheel angle sensor. It uses a new magnetism-sensitive element that transfers mechanical rotation into electrical signal as output, enabling noncontact measurement of the rotational angle.

The sensor's output shaft cannot withstand potentially harmful radial or axial torsion, ensuring that the proper installation of the sensor is a prerequisite, and precision is critical to the sensor. There are two methods to mount the front-wheel angle sensor with

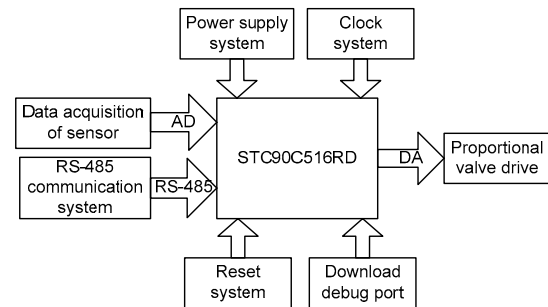

Fig. 3 Hardware block diagram



Fig. 4 WYH-3 type angular displacement sensor

an output shaft. One is to mount the output shaft coaxially on the rotational axis to be measured. This is difficult because when the required high concentricity from the device cannot be obtained, the transmission accuracy is reduced, and the sensor may potentially be damaged. The other is to mount the sensor on a different shaft that enables good transmission accuracy without the requirement of concentricity.

A parallelogram structure is used to install the front-wheel angle sensor. Without concentricity concern, the angle of the front wheel is transmitted to the sensor exactly by the structure. Fig. 5 shows the physical installation.

As the deviation between the measured rotation and actual angles is inevitably observed after installation, it is necessary to calibrate the front-wheel angle sensor before use. The regression equation obtained from the calibration is $y = -34.277x + 95.673$, where y is the angle and x the voltage. The calibration result is shown in Fig. 6.

4 Control algorithm

The automatic steering system in farming equipment is, in general, a closed-loop control system, where the controller receives signals to regulate the steering angle and the feedback signals are transmitted

to the controller. The proportional-integral-derivative (PID) control algorithm used in this study has been widely adopted for its simplicity and independence of the accuracy of the system model. The diagram of a typical PID closed-loop control system is shown in Fig. 7. The corresponding control law is as follows:

$$u(t) = K_p \left[e(t) + \frac{1}{T_i} \int_0^t e(t) dt + T_D \frac{de(t)}{dt} \right] + u_0, \quad (1)$$

where $u(t)$ is the output of the controller, u_0 the initial value, $e(t)$ the error signal, T_D the differentiating time constant, T_i the integration time constant, and K_p the proportion gain.

As the control conducted by digital computers is discrete, the differential and integral terms must be

discretized rather than being incorporated directly into Eq. (1) (Åström *et al.*, 2001). Using the rectangular integral to approximate the exact integration with sampling period T , Eq. (1) is discretized as follows:

$$u(k) = K_p \left[e(k) + \frac{T}{T_i} \sum_{j=0}^k e(j) + T_D \frac{e(k) - e(k-1)}{T} \right] + u_0. \quad (2)$$

Eq. (2) is the positional PID control algorithm, the output of which is always based on the last state. A large k brings a heavy burden to the computer because of cumulative calculation. Moreover, as $u(k)$ is the position of the actuator, a computer error which makes $u(k)$ vary significantly could lead to major accidents, which is unexpected in the actual situation. Accordingly, the incremental PID control algorithm, with output of the digital controller being the increment of the controlled variables, comes into use. According to Eq. (2), we have the following expressions:

$$u(k-1) = K_p \left[e(k-1) + \frac{T}{T_i} \sum_{j=0}^{k-1} e(j) + T_D \frac{e(k-1) - e(k-2)}{T} \right] + u_0, \quad (3)$$

$$\begin{aligned} \Delta u(k) &= u(k) - u(k-1) \\ &= K_p [e(k) - e(k-1)] + K_p \frac{T}{T_i} \\ &\quad + K_p \frac{T_D}{T} [e(k) - 2e(k-1) + e(k-2)] \\ &= K_p [e(k) - e(k-1)] + K_i e(k) \\ &\quad + K_D [e(k) - 2e(k-1) + e(k-2)], \end{aligned} \quad (4)$$

where $K_i = \frac{K_p T}{T_i}$ and $K_D = \frac{K_p T_D}{T}$.

Traditionally, these PID controller gains are obtained by applying the Ziegler-Nichols method, which is used for tuning PID controller gains (Ziegler and Nichols, 1993). Aiming to eliminate the vibration caused by frequent motions, PID with dead zones is used in the control system. The corresponding equation is expressed as follows:

$$e'(k) = \begin{cases} 0, & |e(k)| \leq |e_0|, \\ e(k), & |e(k)| > |e_0|. \end{cases} \quad (5)$$

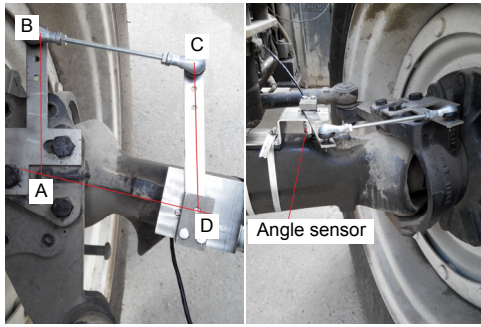

Fig. 5 Physical installation map of the angular displacement sensor

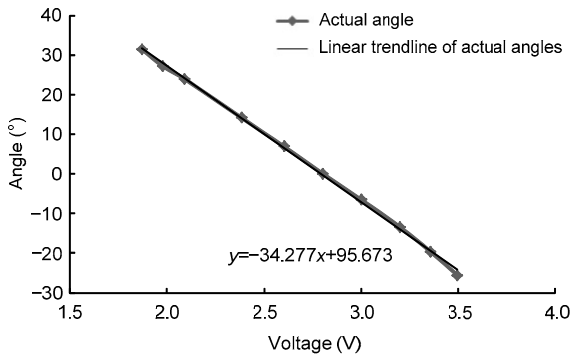

Fig. 6 Actual sensor calibration curve

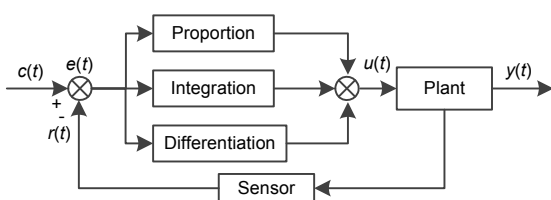

Fig. 7 Diagram of a typical PID closed-loop control system

The working process of the automatic steering system is as follows: when the host computer transmits signals of the target angle to the controller through the RS485 bus, the controller collects signals of the turning angle of the front wheel by the ADC and determines the acquired angle. When the deviation between the target angle ($c(t)$ in Fig. 7) and the acquired angle ($r(t)$ in Fig. 7) is smaller than e_0 , the system maintains the driving angle. When the deviation is greater than e_1 (upper limit), the proportional valve opens to the fullest. Otherwise, PID control is activated. Fig. 8 shows the logic flow of the automatic steering system. When the deviation is within the control range, the system does not take action, avoiding ineffective regulation and over-frequent steering. Otherwise, the controlled variables become the greatest to allow the system to respond quickly.

5 Experimental results and analysis

To test the response and tracking performance of the PID control valve system, straight-line tracking and sinusoidal tracking were conducted on a

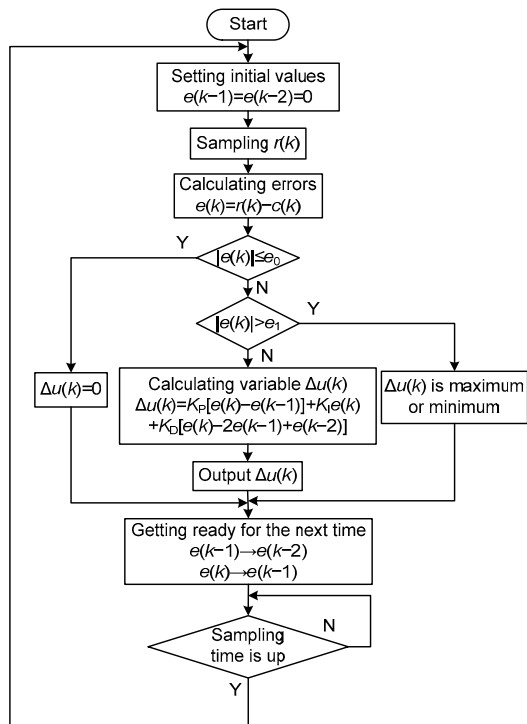

Fig. 8 Program flow chart of the automatic steering system

Foton Lovol TG1254 tractor (Foton Lovol International Heavy Industries Co., Ltd., China). Two modifications were made to the Foton tractor whose steering system uses the open-center, full-hydraulic steering gear: connecting the integrated automatic steering valve block to the tractor’s steering system in parallel or in series. Considering the issue of heat dissipation, the parallel one was selected. The integrated valve block and the original steering system were connected in parallel (Fig. 9).

5.1 Straight-line tracking

The speed of the tractor was set at 3.17 km/h during the experiment. With the target angle being set at zero, straight-line tracking was assumed. Fig. 10 shows the results of straight-line tracking performed on a cement pavement, during which the maximum deviation was 0.56° and the mean absolute deviation was 0.134° , thus indicating that the automatic steering control system has great accuracy and stability.

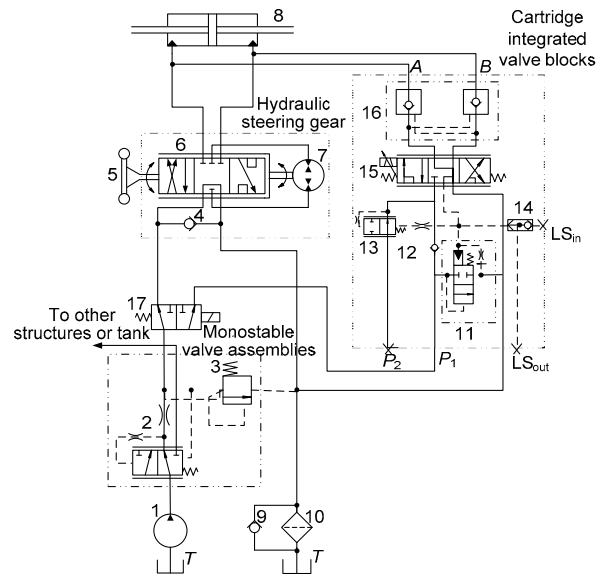

Fig. 9 Schematic representation of the integrated valve blocks and the original steering system connected in parallel P_1 and P_2 : pressure oil ports; T : oil outlet; A and B : steering hydraulic cylinder interfaces; LS_{in} and LS_{out} : load pressure feedback ports; 1: hydraulic pump; 2: single stable shunt valve; 3: safety valve; 4, 9, and 12: check valves; 5: steering wheel; 6: steering servo valve; 7: steering metering motor; 8: hydraulic cylinder; 10: oil filter; 11: differential-pressure spillover valve; 13: pressure-compensated directional valve; 14: spillover throttle valve; 15: proportional directional valve; 16: hydraulic lock; 17: directional valve

5.2 Sinusoidal tracking

Considering that automatic navigation and unmanned driving tractors generally travel along a straight line and that their steering wheels revolve little, the amplitude of the sine wave was set at 3.6° for sinusoidal tracking. The results of the tracking are shown in Fig. 11. The average deviation was 0.271° during the tracking test, the mean absolute deviation was 0.403° , and the maximum deviation was 1.694° , together indicating a good tracking performance.

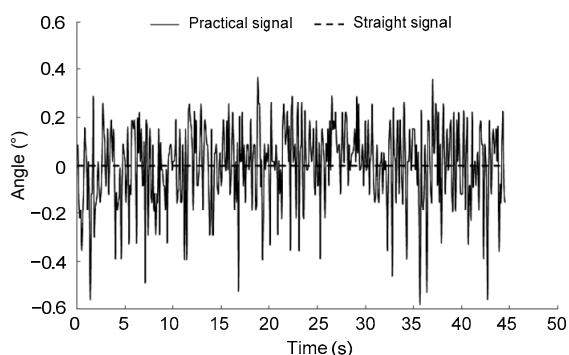

Fig. 10 Graph of straight-line tracking on the concrete way

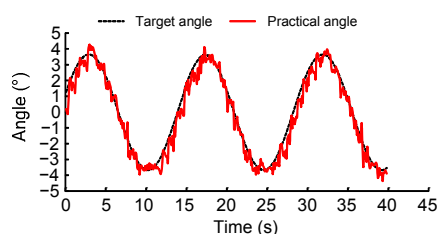

Fig. 11 Graph of sinusoidal tracking during the tractor's walking process

6 Conclusions

A proportional integrated control valve block applicable to a variety of hydraulic steering systems has been developed. The system incorporating the control valve design has been tested using the Foton Lovol TG1254 tractor as the experimental platform. The test results showed that the automatic steering control system has good tracking performance with a fast response, thus meeting the navigation control requirement of agricultural equipment to a certain extent.

References

- Åström, K.J., Albertos, P., Quevedo, J., 2001. PID control. *Contr. Eng. Pract.*, **9**(11):1159-1161. [http://dx.doi.org/10.1016/S0967-0661\(01\)00061-2](http://dx.doi.org/10.1016/S0967-0661(01)00061-2)
- Chen, W.L., Xie, B., Song, Z.H., et al., 2006. Electrohydraulic power steering system for tractors. *Trans. Chin. Soc. Agric. Eng.*, **22**(10):122-125 (in Chinese). <http://dx.doi.org/10.3321/j.issn:1002-6819.2006.10.026>
- Dong, Z.L., Zhang, Q., Han, S.F., 2002. Control of an electrohydraulic steering system using a PID controller with a nonlinear compensation algorithm. *Proc. SPIE*, p.87-95. <http://dx.doi.org/10.1117/12.474438>
- García-Pérez, L., García-Alegre, M.C., Ribeiro, A., et al., 2008. An agent of behaviour architecture for unmanned control of a farming vehicle. *Comput. Electron. Agric.*, **60**(1): 39-48. <http://dx.doi.org/10.1016/j.compag.2007.06.004>
- He, Q., Gao, H.W., Li, H.W., et al., 2007. Electrohydraulic steering control system of tractor based on DSP. *Trans. Chin. Soc. Agric. Mach.*, **38**(5):1-5 (in Chinese). <http://dx.doi.org/10.3969/j.issn.1000-1298.2007.05.001>
- Inoue, K., Murakami, N., Miyaura, S., 2004. A modeling of a movement of a semi-crawler tractor and an adaptive operational steering control. *Proc. Conf. on Automation Technology for Off-Road Equipment*, p.348-359. <http://dx.doi.org/10.13031/2013.17852>
- Luo, X.W., Zhang, Z.G., Zhao, Z.X., et al., 2009. Design of DGPS navigation control system for Dongfanghong X-804 tractor. *Trans. Chin. Agric. Eng.*, **25**(11):139-145 (in Chinese). <http://dx.doi.org/10.3969/j.issn.1002-6819.2009.11.025>
- Qiu, H., Zhang, Q., Reid, J.F., 2001. Fuzzy control of electrohydraulic steering systems for agricultural vehicles. *Trans. ASAE*, **44**(6):1397-1402. <http://dx.doi.org/10.13031/2013.7005>
- Reid, J.F., Zhang, Q., Noguchi, N., et al., 2000. Agricultural automatic guidance research in North America. *Comput. Electron. Agric.*, **25**(1-2):155-167. [http://dx.doi.org/10.1016/S0168-1699\(99\)00061-7](http://dx.doi.org/10.1016/S0168-1699(99)00061-7)
- Shen, W.L., Xue, J.L., Zhang, Y., 2014. Development of electrohydraulic steering system based on agricultural vehicle. *J. Hunan Agric. Univ. (Nat. Sci.)*, **40**(3):325-329 (in Chinese). <http://dx.doi.org/10.13331/j.cnki.jhau.2014.03.020>
- Wu, X.P., Zhao, Z.X., Zhang, Z.G., et al., 2009. Development of automatic steering control system based on Dongfanghong tractor. *Trans. Chin. Soc. Agric. Mach.*, **40**(Z1): 1-5 (in Chinese).
- Zhang, Q., Reid, J.F., Wu, D., 2000. Hardware-in-the-loop simulator of an off-road vehicle electrohydraulic steering system. *Trans. ASAE*, **43**(6):1323-1330. <http://dx.doi.org/10.13031/2013.3029>
- Zhu, Z.X., Chen, J., Yoshida, T., et al., 2007. Path tracking control of autonomous agricultural mobile robots. *J. Zhejiang Univ.-Sci. A*, **8**(10):1596-1603. <http://dx.doi.org/10.1631/jzus.2007.A1596>
- Ziegler, J.G., Nichols, N.B., 1993. Optimum settings for automatic controllers. *J. Dyn. Syst. Meas. Contr.*, **115**(2B): 220-222. <http://dx.doi.org/10.1115/1.2899060>